

APPLICATION NOTE

Modal Analysis using Multi-reference and Multiple-Input Multiple-Output Techniques

H. Herlufsen, Brüel & Kjær, Denmark

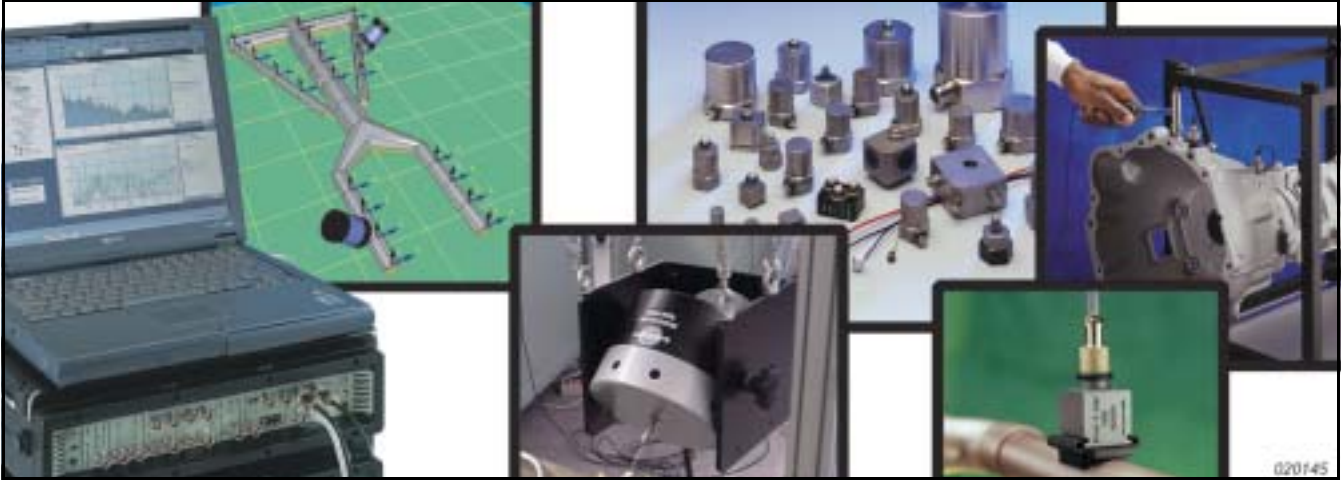

Introduction

Modal analysis based upon classical input/output measurements, known as 'mobility measurements', is a well-proven and well-established application.

A number of practical techniques ranging from simple dual-channel measurements using an impact hammer, to multi-channel Multiple-Input Multiple-Output measurements using more shakers can be applied.

The aim of this application note is to give a brief overview of the mobility measurement-based modal analysis methods and give some practical explanations and hints for use of the different techniques. This includes multi-reference and Multiple-Input Multiple-Output measurement techniques.

A new experimental modal analysis technique based upon measurements of only the outputs of a system has also been developed. This technique can be applied under operational conditions and is, therefore, called Operational Modal Analysis (OMA). Reference 4, referred to at the end of the note, describes OMA in detail, and thus it is not dealt with further in this note.

Abbreviations Used:

DOF	Degree of Freedom
FFT	Fast Fourier Transform
FEM	Finite Element Model
FRF	Frequency Response Function
MIMO	Multiple-Input Multiple-Output
SIMO	Single-Input Multiple-Output
SISO	Single-Input Single-Output

Review of Modal Analysis

The dynamic behavior of a structure in a given frequency range can be modelled as a set of individual modes of vibration. The structure is assumed to behave as a linear, time-invariant system. The parameters that describe each mode are:

- natural frequency or resonance frequency
- (modal) damping
- mode shape

These are called the modal parameters. By using the modal parameters to model the structure, vibration problems caused by these resonances (modes) can be examined and understood. In addition, the model can subsequently be used to come up with possible solutions to individual problems.

The modal parameters can be extracted from a set of Frequency Response Function (FRF) measurements between one or more reference positions and a number of measurement positions required in the model. A position is a point and a direction on the structure and is hereafter called a Degree of Freedom (DOF). The resonance frequencies and damping values can be found from any of the FRF measurements on the structure (except those for which the excitation or response DOF is in a nodal position, that is, where the mode shape is zero). These two modal parameters are therefore called 'Global Parameters'. To accurately model the associated mode shape, frequency response measurements must be made over a sufficient number of DOFs to ensure enough detailed coverage of the structure under test. The extraction of the modal parameters from the FRFs can be done using a variety of mathematical curve-fitting algorithms. In order to calibrate (scale) the modal model, the driving-point measurement, the measurement where the excitation and the response is in the same DOF, needs to be included.

The FRFs are obtained using multi-channel FFT measurements. To arrive at these FRFs, the excitation force (from either an impact hammer or a shaker provided with a proper signal) and responding vibrations are measured. The FRFs can be represented in different ways depending on the measured response used:

- If the vibration response is measured in terms of acceleration, the FRF represents an accelerance function as it gives the complex ratio of acceleration over force in the frequency domain
- If the vibration response is measured in terms of velocity, the FRF represents a mobility function
- If the vibration response is measured in terms of displacement, the FRF represents a compliance function

When used for modal analysis, the three measurements contain the same information and are related to each other via integration or differentiation, which means division or multiplication by $(j\omega)$ in the frequency domain, where (ω) is the angular frequency. In general, these types of measurements are referred to as mobility measurements as the FRFs determine how 'mobile' the structure is, i.e., how much vibration response per input force excitation. For more information on system analysis and FRF measurements see Reference 1.

Fig. 1
An example of an overlay plot showing the magnitude of the three mobility functions (accelerance, mobility and compliance) measured on a mechanical structure

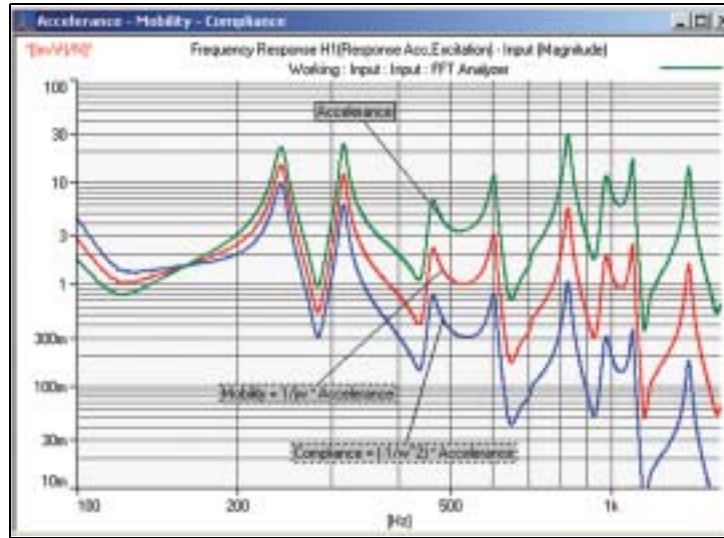

Fig. 1 displays an example of the three mobility functions (accelerance, mobility and compliance) from a structure. An accelerometer is used for the response measurement. The mobility and the compliance functions are calculated from the accelerance, by dividing by $(j\omega)$ and $-(\omega)^2$ respectively. The x- and y-axes are logarithmic so that the difference between the three functions appears in the slope. The y-axis values for the three functions

are offset by a factor of 1000 such that the three curves intersect at 159.15 Hz ($2\pi * 159.15 = 1000$). The units are $(m/s^2)/N$, $(m/s)/N$ and $(m)/N$, respectively.

For impact hammer excitation, each accelerometer response DOF is usually fixed and reflects a reference DOF. The hammer is then moved around the structure and used to excite every DOF needed in the model.

For shaker excitation, each excitation DOF is usually fixed, reflecting each reference DOF. The response accelerometer(s), is moved around the different DOFs on the structure. It must be noted that the effect of the accelerometer(s) being moved around will give a varying mass loading of the structure, which must be evaluated, and possibly taken into account in the subsequent modal model extraction (curve-fitting). The varying mass loading will cause varying shifts of the resonance frequencies, which might or might not be significant depending upon the mass of the accelerometer(s) compared to the dynamic mass of the structure.

If there are enough accelerometers available, they can be mounted on all the DOFs on the structure. This gives a larger corresponding mass loading. However, each DOF's mass loading will subsequently be the same in all the FRFs, providing better consistency in the data. In addition, if the number of measurement channels allows for measurements of all responses simultaneously, the measurement time could be minimised and data consistency maximised.

To avoid mass loading, response measurements can be performed using a Laser Doppler Vibrometer (single-point) or a Scanning Laser Doppler Vibrometer, which measures velocity in the direction of the laser beam.

Fig. 2, Fig. 3 and Fig. 4 illustrate a simple example of FRF measurements from which the modal parameters are extracted. The Brüel & Kjær PULSE™, Multi-analyzer System Type 3560 is used for the measurements. For a basic introduction to modal testing see Reference 2 and Reference 3.

Fig. 2
 Magnitude of one of the accelerance functions. Resonance frequency and damping is extracted for the 2nd mode



Fig. 3
 Waterfall plot of the imaginary part of the FRFs measured along the beam. The 1st and the 2nd bending modes are shown

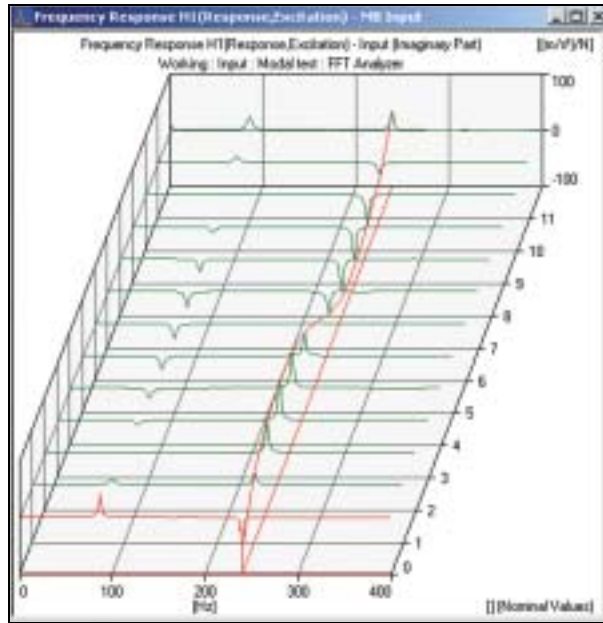

Fig. 4
 The slice extraction of the second bending mode from the waterfall plot in Fig. 3

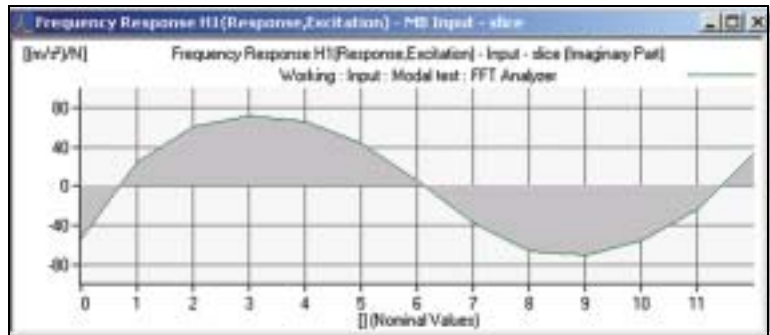

Fig. 2, Fig. 3 and Fig. 4 shows an example with 13 FRF measurements on a beam structure with uncoupled (isolated) modes. Resonance frequency and damping can be extracted from any FRF where the resonance is present and the mode shapes can be extracted from the collection of FRFs at the different DOFs. For uncoupled modes, force and acceleration is 90 degrees out-of-phase at the resonance frequencies, and the peak amplitudes in the imaginary part of the accelerance FRF (at the resonance frequencies) gives an unscaled measure of the mode shapes. This is called quadrature picking.

System Response Model

The relationship between input (force excitation) and output (vibration response) of a linear system is given by:

$$\{Y\} = [H]\{X\} \quad (1)$$

where $\{Y\}$ and $\{X\}$ are the vectors containing the response spectra and the excitation spectra, respectively, at the different DOFs in the model, and $[H]$ is the matrix containing the FRFs between these DOFs.

Equation (1) can also be written as:

$$Y_i = \sum_j H_{ij} X_j \quad (2)$$

where Y_i is the output spectrum at DOF i , X_j is the input spectrum at DOF j , and H_{ij} is the FRF between DOF j and DOF i . The output is the sum of the individual outputs caused by each of the inputs.

The FRFs are estimated from the measured auto- and cross-spectra of and between inputs and outputs. Different calculation schemes (estimators) are available in order to optimise the estimate in the given measurement situation (presence of noise, frequency resolution, etc...).

Single Input

For the classical case of a single input (see Fig. 5), Equation (2) gives the output at any DOF i , with the input at DOF j , as:

$$Y_i = H_{ij} X_j \quad \text{or} \quad H_{ij} = Y_i / X_j \quad (3)$$

since the input is zero at all the DOFs other than j .

Fig. 5
System analysis using single input (and single or multiple outputs).

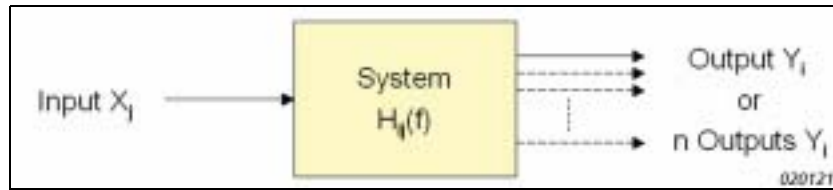

The FRF H_{ij} can be estimated using the various classical estimators such as:

$$H_1 = G_{XY} / G_{XX} \quad (4)$$

or

$$H_2 = G_{YY} / G_{YX} \quad (5)$$

where G_{XX} and G_{YY} are the autospectra of input and output respectively, G_{XY} is the cross-spectrum between input and output, and G_{YX} is the cross-spectrum between output and input (i.e., the complex conjugate of G_{XY})¹. H_1 has the ability, by averaging, to eliminate the influence of uncorrelated noise at the output, whereas H_2 has the ability, by averaging, to eliminate the influence of uncorrelated noise at the input. Compared to H_1 , H_2 is less vulnerable to bias errors at the resonance peaks caused by insufficient frequency resolution (called resolution-bias errors). For detailed information, see Reference 1.

¹ The formulation for cross-spectrum between input and output used here is as follows:

$$G_{XY} = 1/N \sum (X^* Y)$$

where X^* is the complex conjugate of the input spectrum and Y is the spectrum of the output and N is the number of averages (observations). In some literature this is referred to as G_{YX}

Multiple Inputs

The estimation of the FRFs in the case of multiple inputs (see Fig. 6) is a little less straightforward. For uncorrelated inputs, an estimate of the FRFs is given by:

$$[H_1]^T = [G_{XX}]^{-1}[G_{XY}] \quad (6)$$

where $[G_{XX}]$ is the matrix of the auto- and cross-spectra of and between the different input DOFs, $[\]^T$ denotes the transposed matrix, $[\]^{-1}$ denotes the inverse matrix and $[G_{XY}]$ is the matrix of the cross-spectra between inputs and outputs. G_{XY} follows the formulation as given in footnote¹. The inversion of the input cross-spectrum matrix requires, at each frequency of interest, that all the forces are different from zero and that any pair of forces are not to be fully correlated. This can be verified from the input autospectra and the ordinary coherence between the inputs.

Uncorrelated signals are provided to the shakers, but due to the coupling between the shaker systems via the structure, the correlation between the force inputs will never be zero.

Fig. 6
System analysis
using multiple
inputs (and
multiple outputs).

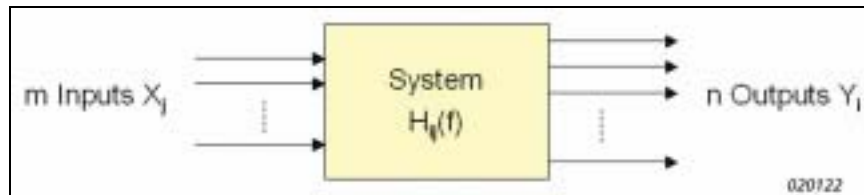

This estimator, which corresponds to H_1 in Equation (4), has the ability by averaging, to eliminate the influence of uncorrelated noise at the output.

Another estimator, called $[H_V]$, is based upon the singular-value decomposition technique. H_V can also be calculated in the case of a single input where H_V is the geometrical mean of H_1 and H_2 and its magnitude value is thus bounded by the magnitude of H_1 and H_2 (i.e., $|H_1| \leq |H_V| \leq |H_2|$). It eliminates, by averaging, the influence of noise, with the assumption that it has the same signal to noise ratio at both the input and the output (see Reference 5).

An $[H_2]$ estimator, corresponding to H_2 in Equation (5), can also be formulated, but the matrix inversion in this case requires that the number of inputs equals the number of outputs and is, therefore, rarely used.

Requirements for Modal Analysis

The important question now comes: *How many of the FRFs in the matrix $[H]$ (see Equation (1)) do we need to measure in order to establish the modal model?*

The answer to this question will tell us how many auto- and cross-spectra we need to measure in order to estimate these FRFs (together with other functions, like the coherence functions needed to investigate and validate the measurements). The answer is: *From a theoretical point of view, only one row or one column of the FRF matrix $[H]$ is required. But, from a practical point of view that is not always sufficient.*

Let us look at different test situations.

Single-reference Modal Test

In a number of test cases, FRF measurement data with only one reference DOF, i.e., measurement of only one row or one column of $[H]$, contain sufficient information to extract the modal model. The assumption is that the selected reference DOF contains information about all the modes, that is to say that the reference DOF is not in a nodal position for any mode. In practice this means that all the modes should be sufficiently 'present' in the FRFs (not buried in other modes or noise) to ensure accurate modal parameter extraction.

In order to identify a proper reference DOF, some pre-testing often has to be performed. If a Finite Element Model (FEM) is available this could be used as well. For a (roving) hammer test, this means that only one response DOF is needed, i.e., only one accelerometer position (point and direction), see Fig. 7. This is an example of a Single-Input Single-Output (SISO) test configuration .

Fig. 7
Roving hammer test with a single response (reference) DOF

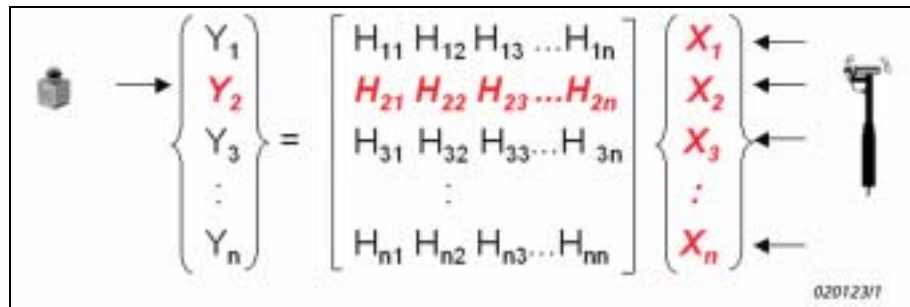

For a (fixed) shaker test, it means that only one excitation DOF is required, i.e., only one shaker position (point and direction)¹, see Fig. 8. If more responses are measured in each measurement, it is an example of a Single-Input Multiple-Output (SIMO) test configuration.

In cases where different modes deflect in different orthogonal directions, a reference DOF with an oblique angle to these directions could be used to ensure sufficient participation of all the modes in the reference DOF.

¹ As discussed earlier, inconsistency in the measured FRFs due to varying mass loading of the accelerometer(s), in cases where the accelerometer has to be moved during the test, must be evaluated and possibly taken into account in the subsequent curve-fitting. 'Local' curve-fitters must be used to allow for local frequency and damping values.

Fig. 8
 Fixed shaker test with a single excitation (reference) DOF. The response transducer(s) must be moved around unless there are as many transducers available as there are response DOFs

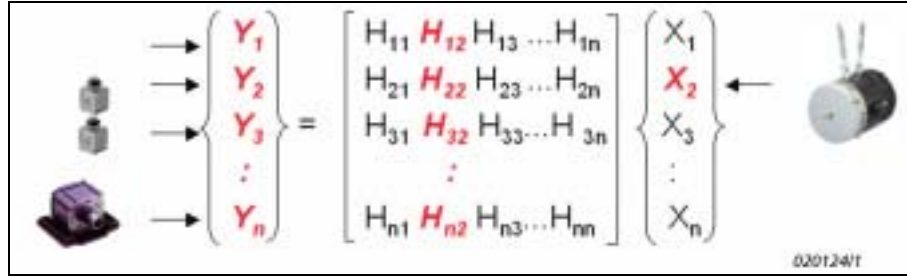

Multi-reference Modal Test

Some test cases require measurements with more than one reference DOF, i.e., measurements of more than one row or more than one column of the FRF matrix $[H]$. This is the situation when it is not possible to find a proper reference DOF. The structure could, for example, exhibit different modes with predominant modal deflections at different parts of the structure, thus making it impossible to find a DOF where all the modes have sufficiently high participation for proper modal model extraction. Such modes are often referred to as local modes. Examples are complex structures composed of several different parts with different structural properties.

Multi-reference testing is also required in cases where the structure has more modes with the same resonance frequency. This is often referred to as 'repeated roots', where 'roots' refer to the solutions to the characteristic equation giving the frequency and damping values of the structure. This is, for example, the case for certain symmetrical structures. The number of rows or columns measured must be (at least) equal to the number of modes at the same frequency. Furthermore, the mode shapes that are to be extracted have to 'look differently' in the reference DOFs. That is to say, the mode shapes for these modes must be linear independent at the reference DOFs. Otherwise, the added reference DOF(s) does not add 'more information' about these modes.

Measuring several rows or columns of the FRF matrix enables calculations of linear combinations of these rows or columns of FRFs to enhance different modes. The classical example is a symmetrical structure measured with two reference DOFs at symmetrical locations. The sum of the FRFs (sum of the two rows or the two columns) enhances the symmetrical modes and the difference enhances the anti-symmetrical modes (see Reference 6).

In the case of a roving hammer test situation, more rows are obtained by including more response DOFs. In order to optimise data consistency and reduce measurement time, the response reference DOFs should be measured simultaneously by using more accelerometers (and more measurement channels), i.e., SIMO. In the cases where different modes deflect in different orthogonal directions, multi-reference measurements with a triaxial accelerometer (three reference DOFs) can be used instead of, as mentioned above, mounting an accelerometer (one reference DOF) at an oblique angle.

Fig. 9, and Fig. 10 show an example of a roving hammer test on an I-beam structure. A triaxial accelerometer, mounted in a corner point, provides three reference DOFs in orthogonal directions and proper estimation of all the modes is obtained. The Brüel & Kjær PULSE™ Multi-analyzer System Type 3560 and Modal Test Consultant Type 7753 are used for generation of geometry and DOF information, making the measurements and validation of these. ME'scopeVES™ from Vibrant Technology, Inc. is used for the modal analysis post-processing.

Fig. 9
A triaxial accelerometer providing three orthogonal reference DOFs at a corner point. The hammer excitation DOFs are shown as well

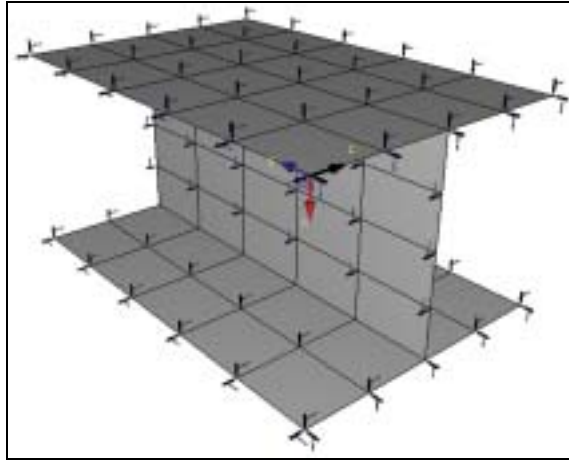

In the case of excitation with one (fixed) shaker, a multi-reference data set could be acquired simply by measuring one column at a time. A measurement is performed with the shaker in one position (one reference DOF) followed by a measurement with the shaker moved to another reference DOF, and so on.

Another, and in many cases a much better, solution is to use more shakers and perform a Multiple-Input Multiple-Output (MIMO) test.

Fig. 10
Left: Mode shape for the 2nd mode with predominant, horizontal modal deflection

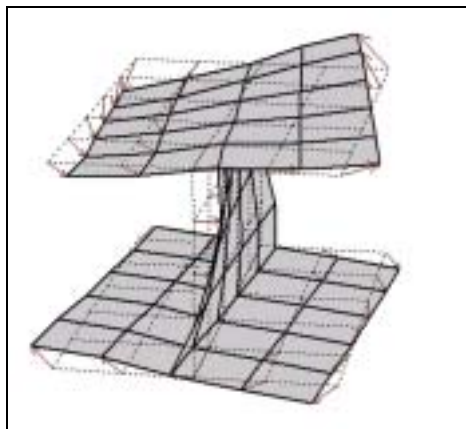

Right: Mode shape for the 4th mode with predominant, vertical modal deflection

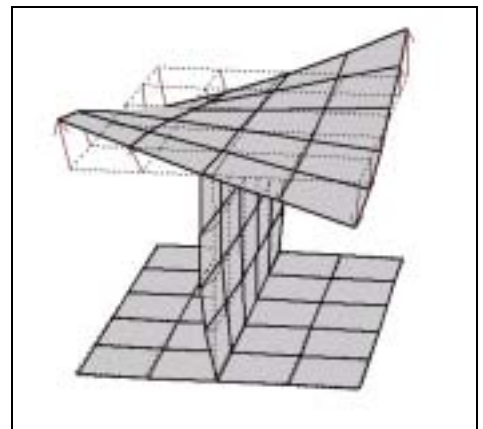

Multiple-Input Multiple-Output Modal Test

Multiple-Input Multiple-Output (MIMO) testing is inherently a multi-reference test. More shakers are used to simultaneously excite the structure at more DOFs, resulting in measurements of more columns of the frequency response function matrix (see Fig. 11).

Fig. 11
MIMO shaker test with two excitation (reference) DOFs. The response transducers must be roved around unless there are sufficient transducers available to cover all the response DOFs

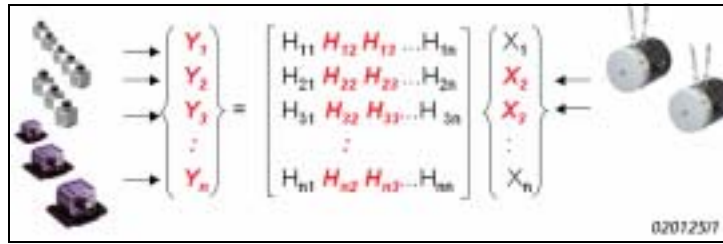

With this type of testing, uncorrelated random (continuous, burst or periodic random) excitation signals are used. Burst random and periodic random signals have the ability to provide leakage-free esti-

mates of the FRFs, i.e., without resolution-bias errors, which is an advantage compared to continuous random signals (see Reference 1).

The main advantage of MIMO is that the input-force energy is distributed over more locations on the structure. This provides a more uniform vibration response over the structure, especially in cases of large and complex structures and structures with heavy damping. In order to get sufficient vibration energy into these types of structures, there is a tendency to 'overdrive' the excitation DOF when only a single shaker is used. This can result in non-linear behaviour and deteriorates the estimation of the FRFs. Excitation in more locations often also provides a better representation of the excitation forces that the structure experiences during real-life operation.

Measuring the FRFs from more columns simultaneously provides other key advantages over sequential column measurements (moving a single shaker between the excitation DOFs), such as increased consistency in the data set and shorter measurement time. Data consistency is of paramount importance when multi-reference data are used in the modal extraction algorithms (polyreference curve-fitting) or when linear combinations of columns are calculated for modal enhancement.

It should be noted that the recognised normal mode testing method (see Reference 7), is one that uses fixed sine excitation with multiple shakers. One mode is analysed at a time by tuning the excitation frequency to the resonance frequency and setting the amplitude and phase of the force signals such that only that mode is being excited (i.e., setting the force signals according to the mode shape of the mode).

Examples

In the following examples, Brüel & Kjær's PULSE™, Multi-analyzer System Type 3560 and Modal Test Consultant Type 7753 are used for generation of geometry and DOF information, performing the measurements and the validation of these. ME'scopeVES™ from Vibrant Technology, Inc. is used for the modal analysis post-processing.

Fig. 12
Geometry of a landing gear structure and associated measurement DOFs. A MIMO test with two shakers is used. Responses in two directions in 20 points as well as in the two reference DOFs, (a total of 42 DOFs), are measured.

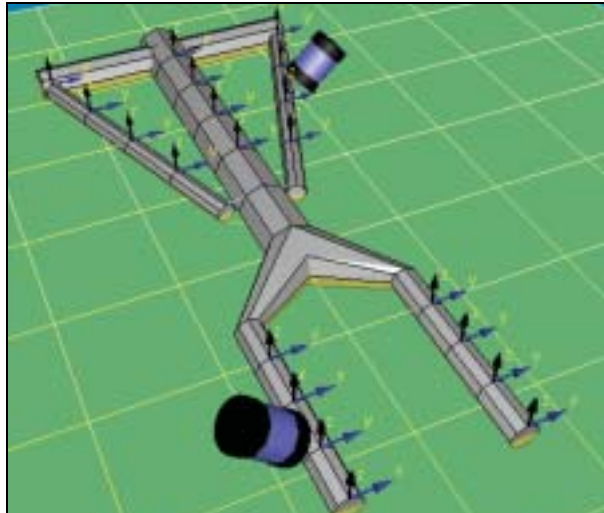

Fig. 12 shows an example of a landing gear structure that is tested using MIMO measurements. Two shakers are attached at oblique angles in two opposite positions of the structure in order to ensure excitation of all the modes. Acceleration responses are measured in two directions in 20 points as well as in the two reference DOFs, i.e. a total of 42 DOFs. A multi-reference hammer test with two response DOFs is used for preliminary investigations and for selection of the reference DOFs in the MIMO test.

Fig. 13, Fig. 14 and Fig. 15 show the H_1 FRF estimates at the driving point DOFs, the corresponding multiple coherence functions, and the ordinary coherence between the input forces. The multiple coherence function measures the degree of linear relationship between an output and all the inputs. Low multiple coherence can be caused by uncorrelated noise, insufficient frequency resolution (resolution-bias errors) or non-linear behaviour. None of these problems are present in the measurement. The ordinary coherence between the two forces shows that the forces are sufficiently uncorrelated at all frequencies to allow for proper calculations of the (MIMO) FRFs (see Equation 6).

Fig. 13
Driving point FRFs H_1

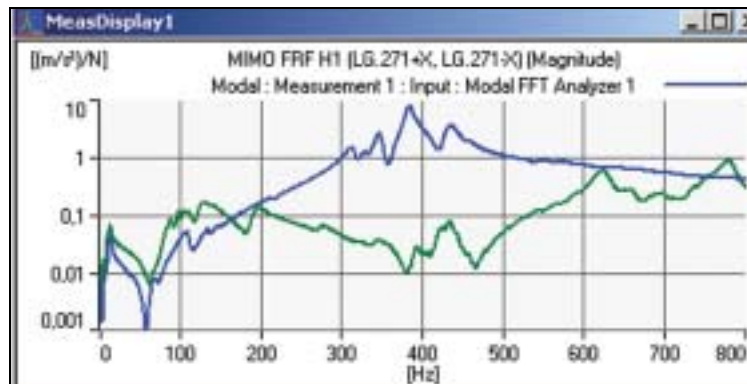

Fig. 14
Multiple coherence of the driving points (reference DOFs)

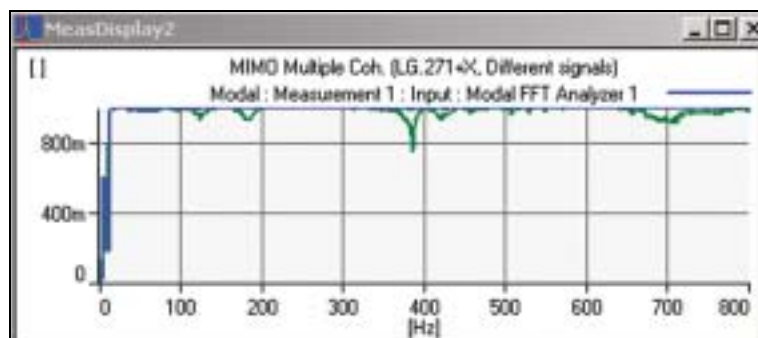
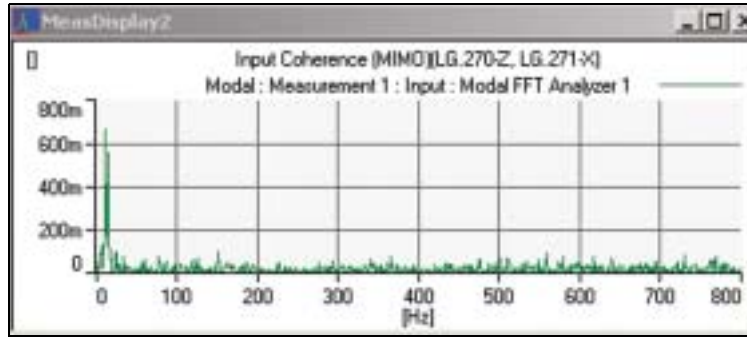
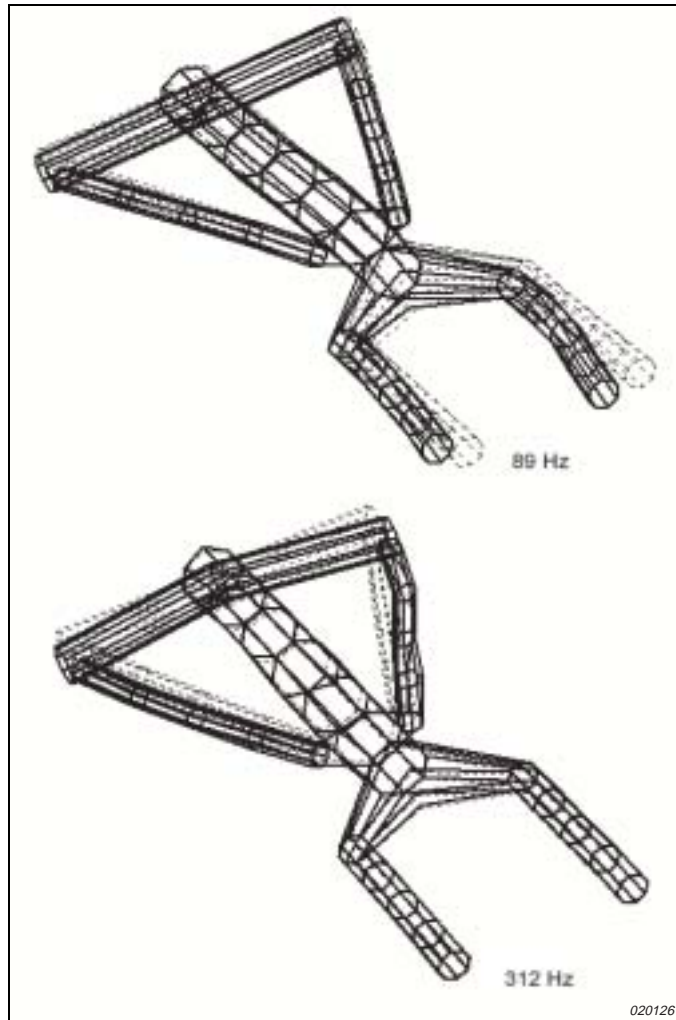

Fig. 15
Ordinary coherence between the two input forces



Two of the estimated mode shapes are shown in Fig. 16. The two modes shown, have predominant modal deflections at different parts (lower part and upper part) of the structure, each being represented by a reference DOF.

Fig. 16
Two of the estimated mode shapes, at 89 Hz and 312 Hz



A multi-reference modal test is required for separating the torsional and bending modes exhibited in the plate structure in Fig. 17. A MIMO measurement with two shakers positioned at two corner points is performed, and uncorrelated random signals are applied to the shakers. These points are chosen such that the two modes are linearly independent at the two reference DOFs (modal deflections are in-phase for the bending mode and out-of-phase for the torsional mode). Responses are measured in 12 DOFs (12 points in vertical direction) simultaneously.

Fig. 17
 Plate structure
 which exhibits two
 modes (torsional
 and bending) at
 (almost) the same
 frequency.



Fig. 18, Fig. 19, Fig. 20 and Fig. 21 show the H_1 estimate of the FRFs (two columns), the multiple coherences, the autospectra of the force signals, and the ordinary coherence between these. The multiple coherence is almost one in the frequency range of the elastic modes indicating that there are no problems concerning uncorrelated noise, insufficient frequency resolution (resolution-bias errors) or non-linear behaviour. The autospectra of the force signals indicates proper excitation force at all frequencies, and the ordinary coherence shows that the forces are not fully coherent at any frequency allowing for proper calculations of the (MIMO) FRFs (see Equation 6).

Fig. 18
 H_1 estimates of the
 FRFs (two columns)
 from the MIMO
 measurement on
 the plate structure
 seen in Fig. 17

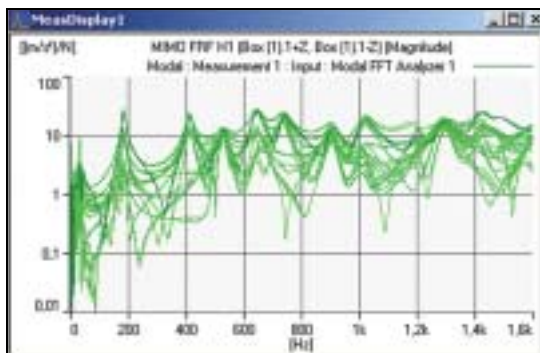

Fig. 19
 Multiple coherence
 functions

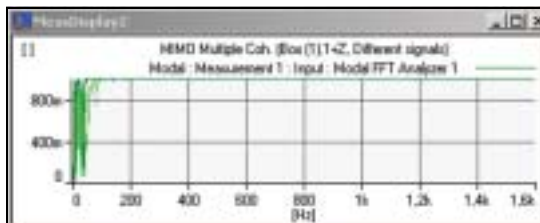
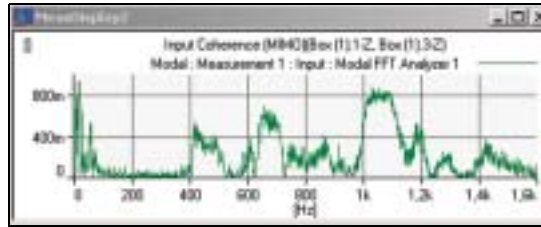

Fig. 20
 Autospectra of the
 two force signals



Fig. 21
Ordinary coherence
between the forces



Inspection of the FRFs (Fig. 18) does not reveal the existence of more modes at the first resonance peak. A mode indicator function calculated by singular-value composition of the FRFs indicates two modes at approximately 182 Hz as shown in Fig. 22.

Fig. 22
Complex Mode
Indicator Function
(CMIF) applied on
the (MIMO) FRFs
indicating 2 modes
at approximately
182 Hz

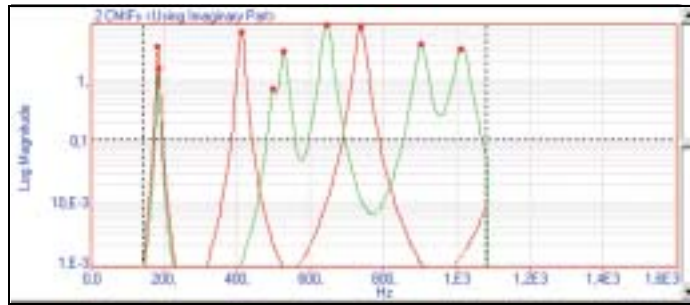
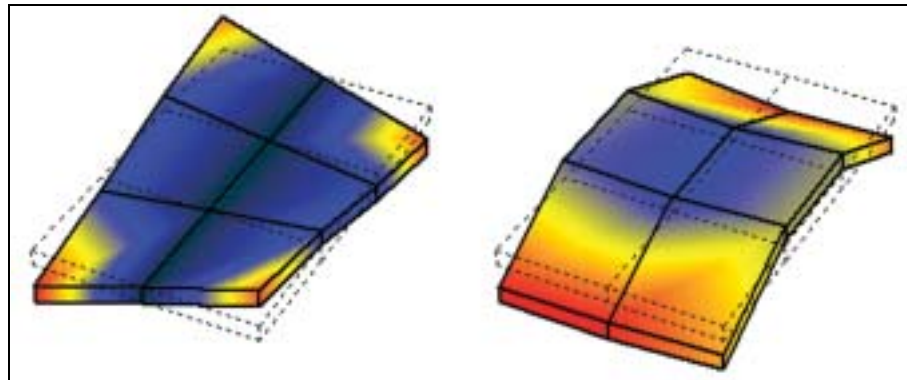

Fig. 23 shows the estimated mode shapes of these two modes. The estimated frequencies are 182.2 Hz and 182.8 Hz with damping values of 2.75% and 2.83%, respectively.

Fig. 23
Mode shapes of the
two modes at
182 Hz (estimated
frequencies of
182.2 Hz and
182.8 Hz)



A proper multi-reference test on this structure could also be obtained using a (roving) hammer test with two accelerometers at the two reference DOFs.

Conclusion

A brief overview of the different modal analysis techniques based upon input/output mobility measurements has been given. The advantages of the different techniques and the practical aspects of when they could or should be applied has been discussed. Multi-reference modal testing is required in situations where a single-reference DOF featuring sufficient participation of all modes cannot be found, or where more modes exist at the same frequency. Multiple-Input Multiple-Output (MIMO) testing provides better distribution of the input force energy, which is especially important for large, complex and heavily damped structures. Additionally, it gives advantages in terms of improved consistency in the data and reduced test time.

References

- [1] Herlufsen, H.: Dual Channel FFT Analysis Part 1 & 2.
Brüel & Kjær Technical Review No.1 & 2 1984. BV 0013-11 & BV 0014-11
- [2] Døssing, O.: Structural Testing Part 1 & 2,
Brüel & Kjær Primers. BR 0458-11 & BR 0507-11
- [3] Brüel & Kjær Application Note: How to determine the modal parameters of simple structures. BO 0177-11
- [4] Herlufsen, H., Møller, N.: Operational Modal Analysis of a Wind Turbine Wing using Acoustical Excitation. Brüel & Kjær Application Note BO 0500-11
- [5] Vold, H., Crowley, J., Rocklin, G.: A comparison of H_1 , H_2 and H_V frequency response functions. Proceedings, IMAC, 1985.
- [6] Allemang, R.J., Rost, R.W., Brown, D.L.: Dual Input Estimation of Frequency Response Functions for Experimental Modal Analysis of Aircraft Structures. Proceedings, IMAC 1982
- [7] Zaveri, K.: Modal Analysis of Large Structures - Multiple Exciter Systems. Brüel & Kjær Publication 1985. BT 0001-12

Product Literature

Product Data

Modal Test Consultant Type 7753 (BP 1850)
Operational Modal Analysis Type 7760 (BP 1889)

System Data for PULSE™ Type 3560

Hardware (BU 0228)
Software (BU 0229)

TRADEMARKS

PULSE and Modal Test Consultant are trademarks of Brüel & Kjær Sound & Vibration Measurement A/S.
ME'scopeVES is a trademark of Vibrant Technology, Inc.

